

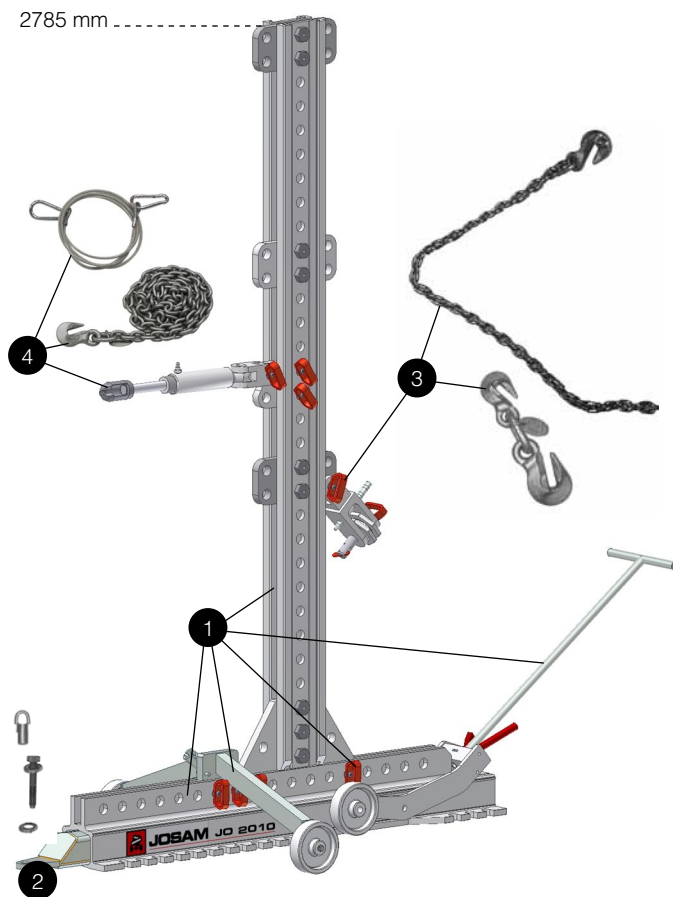

CT 2006 AL/10775
Straightening kit - pulling
Riktsats - drag
Richtsatz - Ziehen

#	Article #	Order #	Pcs.	EN	SE	DE
1	CT 21 AL	10778	1	Tower kit	Tornsats	Turmsatz
2	CT 31	10780	1	Nose bracket	Nosinfästningssats	Nasenhaltersatz
3	CT 41 AL	10781	1	Bracket kit for anchoring	Infästningssats för golvförankring	Haltersatz für Bodenverankerung
4	CT 51 AL	10782	1	Pulling kit with 127 mm stroke	Dragsats med 127 mm slaglängd	Ziehsatz mit 127 mm Hub



Recommended pump: I-PP71 K (6:01) or I-PP40 K (6:07)
 Pumprekommendation: I-PP71 K (6:01) eller I-PP40 K (6:07)
 Pumpen-Empfehlung: I-PP71 K (6:01) oder I-PP40 K (6:07)



CT 2007 AL/10776

Straightening kit - pulling - extra high

Riktsats - drag - extra hög

Richtsatz - Ziehen - extra hoch

#	Article #	Order #	Pcs.	EN	SE	DE
1	CT 25 AL	10779	1	Tower kit	Tornsats	Turmsatz
2	CT 31	10780	1	Nose bracket	Nosinfästningssats	Nasenhaltersatz
3	CT 41 AL	10781	2	Bracket kit for anchoring	Infästningssats för golvförankring	Haltersatz für Bodenverankerung
4	CT 51 AL	10782	1	Pulling kit with 127 mm stroke	Dragsats med 127 mm slaglängd	Ziehsatz mit 127 mm Hub

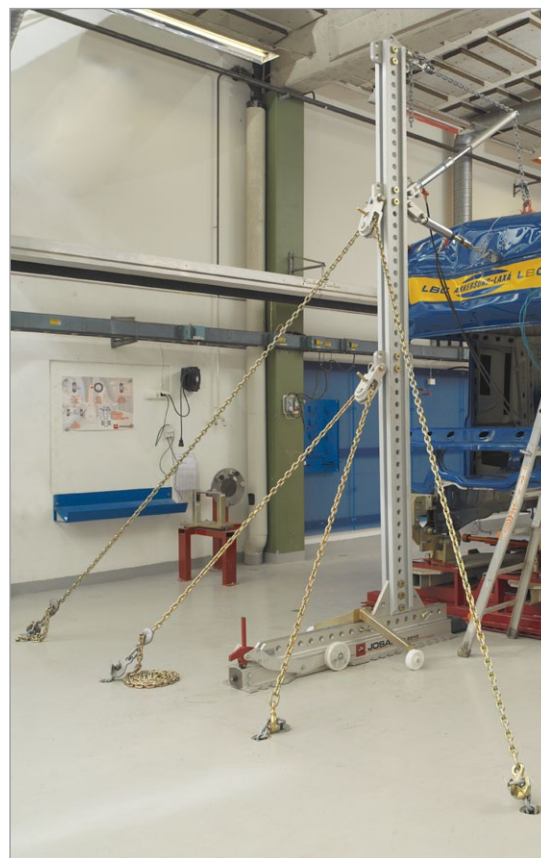
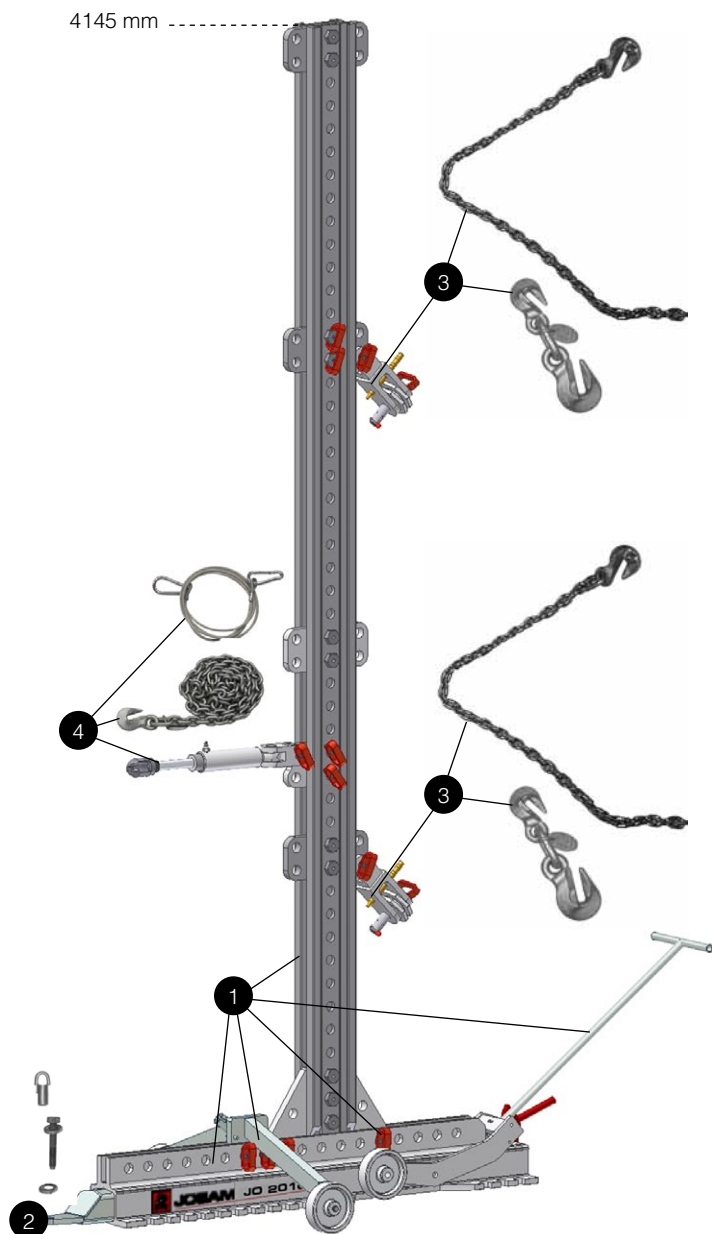

Recommended pump: I-PP71 K (6:01) or I-PP40 K (6:07)
 Pumprekommendation: I-PP71 K (6:01) eller I-PP40 K (6:07)
 Pumpen-Empfehlung: I-PP71 K (6:01) oder I-PP40 K (6:07)



JO2324 AP K/14124

Floor anchoring kit for cab straightening according to drawing JO2324

Golvförankringskit för hyttriikt enligt ritning JO2324

Verankerungssatz für Fahrerhausrichten laut Plan JO2324

#	Article #	Order #	Pcs.	EN	SE	DE
1	JOATP150	11720	24	Anchoring for floor	Förankring för golv	Verankerung für Boden
2	JOATP151	11721	4	Anchoring for cab bench and CT 71	Förankring för hyttbänk och CT 71	Verankerung für Richtbank und CT 71
3	JO2393	11552	4	Bolt 180 mm for JOATP151	Bult 180 mm til JOATP151	Bolzen 180 mm für JOATP151
4	TBRB 31x58x8	12689	4	Washer	Bricka	Scheibe

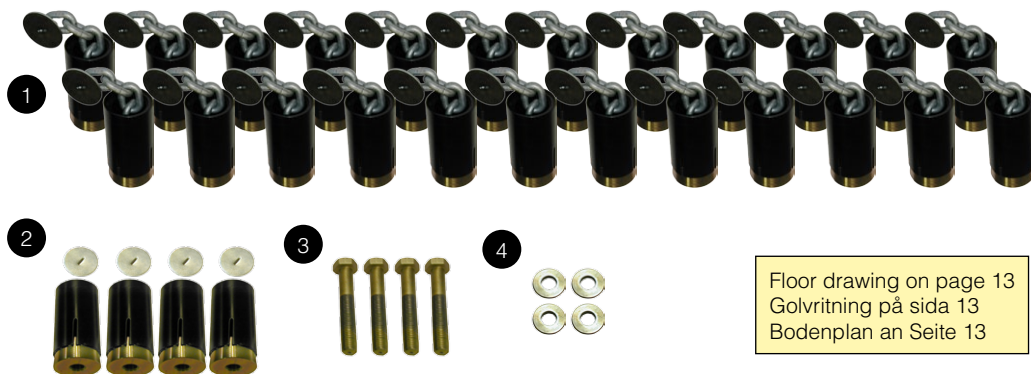

Floor drawing on page 13
 Golvritning på sida 13
 Bodenplan an Seite 13



JO2324B AP K/14125

Floor anchoring kit for bus straightening according to drawing JO2324-B

Golvförankringskit för bussrikt enligt ritning JO2324-B

Verankerungssatz für Busrichten laut Plan JO2324-B

#	Article #	Order #	Pcs.	EN	SE	DE
1	JOATP150	11720	16	Anchoring for floor	Förankring för golv	Verankerung für Boden
2	JOATP151	11721	9	Anchoring for cab bench and CT 71	Förankring för hyttbänk och CT 71	Verankerung für Richtbank und CT 71



Floor drawing on page 14
 Golvritning på sida 14
 Bodenplan an Seite 14



JO2324C AP K/14126

Floor anchoring kit for bus and cab straightening according to drawing JO2324-C

Golvförankringskit för buss- och hyttriikt enligt ritning JO2324-C

Verankerungssatz für Bus- und Fahrerhausrichten laut Plan JO2324-C

#	Article #	Order #	Pcs.	EN	SE	DE
1	JOATP150	11720	16	Anchoring for floor	Förankring för golv	Verankerung für Boden
2	JOATP151	11721	13	Anchoring for cab bench and CT 71	Förankring för hyttbänk och CT 71	Verankerung für Richtbank und CT 71



Floor drawing on page 15
Golvrättning på sida 15
Bodenplan an Seite 15

CT 71/10786

Anchoring beam complete

Förankringsbalk komplett

Verankerungsstrebe komplett

#	Article #	Order #	Pcs.	EN	SE	DE
1	JO2326	11514	1	Anchoring beam 3 m long	Förankringsbalk 3 m lång	Verankerungsstrebe 3 m lang
2	JO2394	11553	3	Bolt 260 mm	Bult 260 mm	Bolzen 260 mm
3	TBRB 31x58x8	12689	3	Washer	Bricka	Scheibe

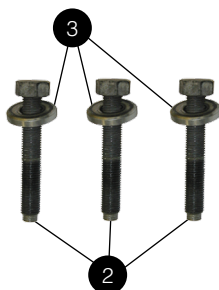
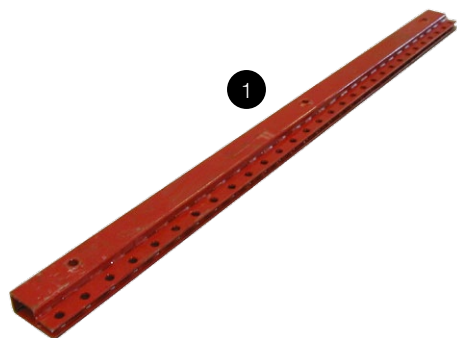

The tower is not included in the set.
Tornet ingår ej i satsen.
Das Turm ist nicht im Satz enthalten.



CT 61 AL/10784

Straightening kit for vector pull and press

Riktsats för vektordrag och tryckfunktioner

Richtsatz für Vektorziehen und Pressen

#	Article #	Order #	Pcs.	EN	SE	DE
1	I-CF310	10957	1	10-ton hydraulic cylinder 300 mm stroke	10 ton hydraulisk cylinder 300 mm slaglängd	10 Tonnen hydraulisch Zylinder 300 mm Hub
2	JO 2370 K	11123	1	Knot complete with cylinder bracket	Knut komplett med cylinderfäste	Knoten komplett mit Zylinderhalter
3	JO1393 AL	11315	1	Extension pipe 200 mm	Förlängningsrör 200 mm	Verlängerungsrohr 200 mm
4	JO1599 AL	11331	1	Extension pipe 350 mm	Förlängningsrör 350 mm	Verlängerungsrohr 350 mm
5	JO1601 AL	11332	2	Extension pipe 600 mm	Förlängningsrör 600 mm	Verlängerungsrohr 600 mm
6	JO2322 AL	11512	1	Knot in aluminium	Knut i aluminium	Knoten aus Aluminium
7	JO2337	11522	1	Press head complete	Tryckhuvud komplett	Druckkopf komplett
8	JO2370 AL	11542	1	Cylinder bracket in aluminium	Cylinderfäste i aluminium	Zylinderhalter aus Aluminium
9	JO2423 AL	11567	2	Ear in aluminium	Öra i aluminium	Ohr aus Aluminium
10	JO2428-1	11570	1	Chain bracket 11 mm	Kättingfäste 11 mm	Kettenhalter 11 mm
11	JO2450-1	11594	6	Pin 35x100 in aluminium	Sprint 35x100 i aluminium	Splint 35x100 aus Aluminium
12	KL10-10-3M	12301	1	Chain 3 m with one hook	Kätting 3 m med krok	Kette 3 M mit einem Haken
13	JO2398	30102	1	Safety wire	Säkerhetsvajer	Sicherheitsdrahtseil

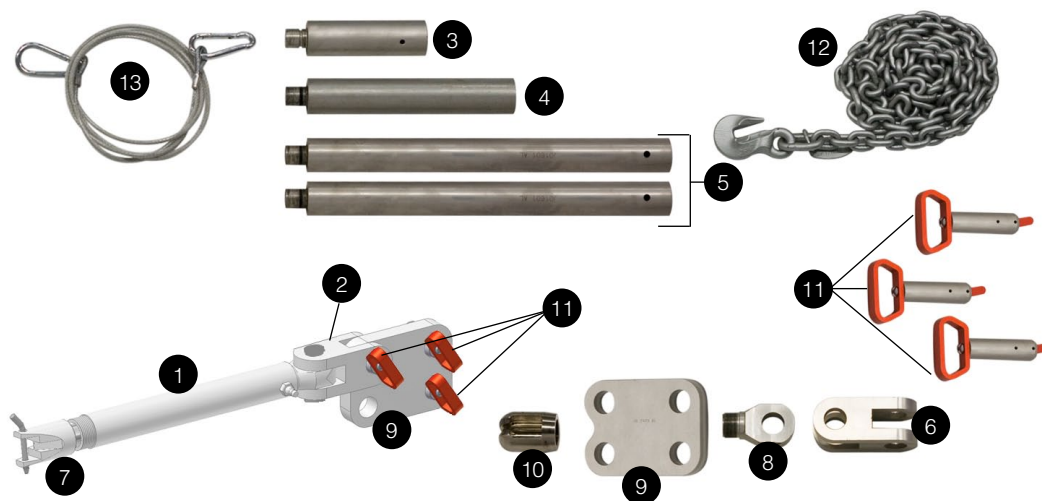



CT 62 AL/10785

Additional kit for cab and bus straightening

Tilläggsats hytt- och bussrikt

Ergänzungssatz Fahrerhaus- und Busrichten

#	Article #	Order #	Pcs.	EN	SE	DE
1	JO 1500 K	11105	1	Universal pulling hook, complete	Universalkrok AL, komplett	Zugarm, universal mit Zubehör
2	JO2381	11548	1	Pull clamp, straight+angle 100 mm	Dragklämma rak+vinklad 100 mm	Zugklemme, gerade+Winkel 100 mm
3	JO2382	11549	1	Pull clamp, stepless 90 mm	Dragklämma steglös 90 mm	Zugklemme, stufenlos 90 mm
4	JO2383	11550	1	Pull clamp, 75 mm	Dragklämma 75 mm	Zugklemme, 75 mm
5	KL10-2K	12303	1	Double hook 10 mm	Dubbelkrok 10 mm	Doppelhaken 10 mm
6	KL8-2K	12309	1	Double hook 8 mm	Dubbelkrok 8 mm	Doppelhaken 8 mm
7	KL8-8-3M	12310	1	Chain 4 ton 3 m with one hook	Kätting 4 ton 3 m med krok	Kette 4 Tonnen 3 m mit einem Haken

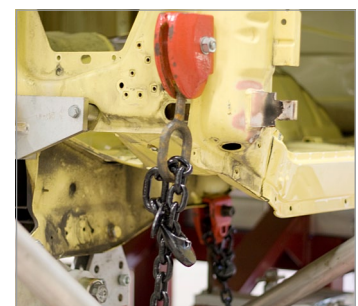
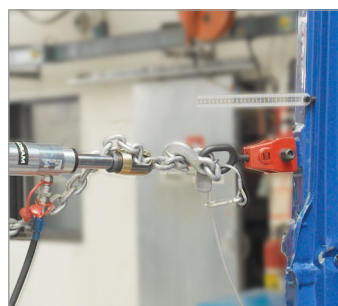



CT HR2 AL/10788

Cab repair high reach beam set for JO 2010 - CT

Hyttriktstålk för JO 2010 - CT

Fahrerhausrichtstrebe für JO 2010 - CT

#	Article #	Order #	Pcs.	EN	SE	DE
1	CT 31	10780	1	Nose bracket	Nosinfästningssats	Nasenhaltersatz
2	CT 41 AL	10781	1	Bracket kit for anchoring	Infästningssats för golvförankring	Haltersatz für Bodenverankerung
3	CT 51 AL	10782	1	Pulling kit with 127 mm stroke	Dragsats med 127 mm slaglängd	Ziehsatz mit 127 mm Hub
4	JO2349	11524	1	Wheel setting	Hjulställ	Radgestell
5	JO2420-1 AL	11562	1	High reach beam in aluminium, 2645 mm	Riktstålk i aluminium, 2645 mm	Richtstrebe aus Aluminium, 2645 mm
6	JO2450-1	11594	4	Pin 35x100 in aluminium	Sprint 35x100 i aluminium	Steckbolzen 35x100 aus Aluminium

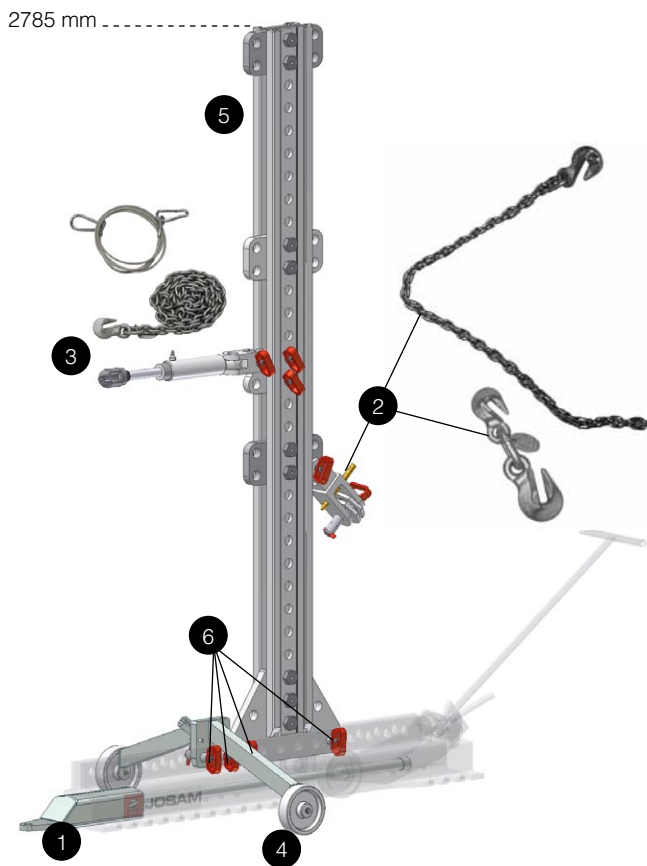

Recommended pump: I-PP71 K (6:01) or I-PP40 K (6:07)
 Pumprekommendation: I-PP71 K (6:01) eller I-PP40 K (6:07)
 Pumpen-Empfehlung: I-PP71 K (6:01) oder I-PP40 K (6:07)

These kits assume that the JO 2010 counterstay trolley is already available in the workshop.
 Dessa satser förutsätter att JO 2010 motstållsbrygga finns i verkstaden.
 Diese Sätze setzen voraus, dass die Gegenbrücke JO 2010 schon vorhanden ist.



CT HR2 AL HIGH/10789

Cab repair high reach beam set for JO 2010 - CT - extra high

Hyttriktbalk för JO 2010 - CT - extra högt

Fahrerhausrichtstrebe für JO 2010 - CT - extra hoch

#	Article #	Order #	Pcs.	EN	SE	DE
1	CT 31	10780	1	Nose bracket	Nosinfästningssats	Nasenhaltersatz
2	CT 41 AL	10781	2	Bracket kit for anchoring	Infästningssats för golvförankring	Haltersatz für Bodenverankerung
3	CT 51 AL	10782	1	Pulling kit with 127 mm stroke	Dragsats med 127 mm slaglängd	Ziehsets mit 127 mm Hub
4	JO2349	11524	1	Wheel setting	Hjulställ	Radgestell
5	JO2420-2 AL	11563	1	High reach beam in aluminium, 4005 mm	Riktbalk i aluminium, 4005 mm	Richtstrebe aus Aluminium, 4005 mm
6	JO2450-1	11594	4	Pin 35x100 in aluminium	Sprint 35x100 i aluminium	Steckbolzen 35x100 aus Aluminium

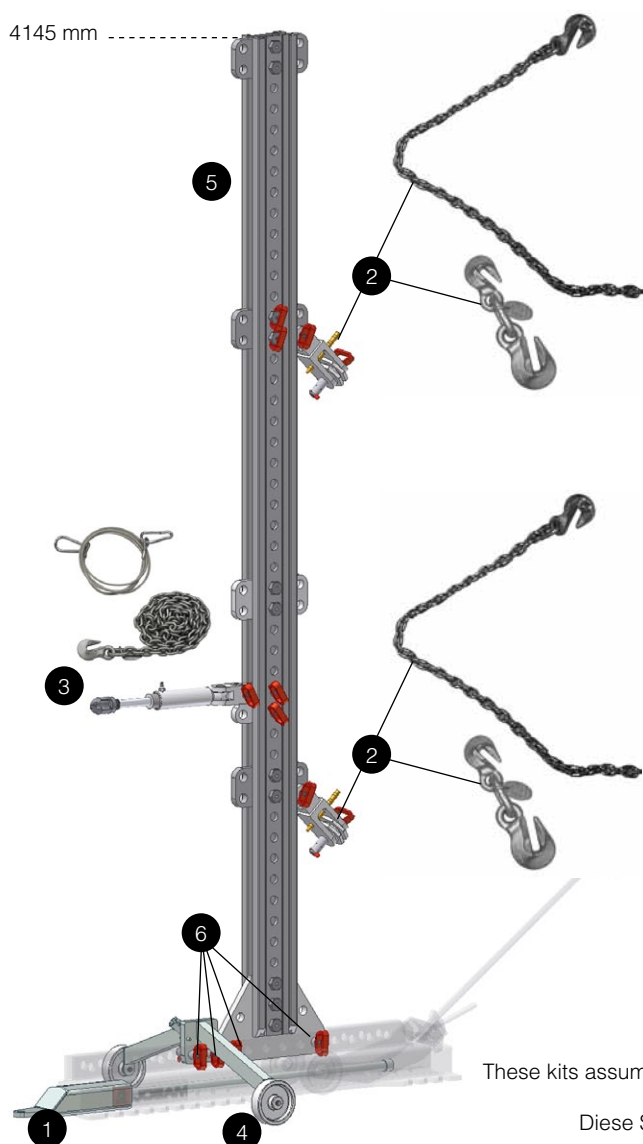

Recommended pump: I-PP71 K (6:01) or I-PP40 K (6:07)
 Pumprekommendation: I-PP71 K (6:01) eller I-PP40 K (6:07)
 Pumpen-Empfehlung: I-PP71 K (6:01) oder I-PP40 K (6:07)

These kits assume that the JO 2010 counterstay trolley is already available in the workshop.
 Dessa satser förutsätter att JO 2010 mothållsbrygga finns i verkstaden.
 Diese Sätze setzen voraus, dass die Gegenbrücke JO 2010 schon vorhanden ist.



CT 31/10780

Nose bracket kit

Nosinfästningssats

Nasenhaltersatz

#	Article #	Order #	Pcs.	EN	SE	DE
1	JO179	11360	1	Spacer	Distansrör	Distanzscheibe
2	JO2359	11529	1	Nose bracket	Nosfäste	Nasenhalter
3	SR12	12596	1	Pin Ø 30x50 chamfered	Sprint Ø 30x50 fasad	Steckbolzen Ø 30x50 angefast
4	TBRB 31x58x8	12689	1	Washer	Bricka	Scheibe
5	JO2354	13095	1	Screw, complete	Skruv, komplett	Schraube, komplett
6	JO2399	13791	1	Bolt 200 mm for JOATP151	Bult 200 mm till JOATP151	Bolzen 200 mm für JOATP151

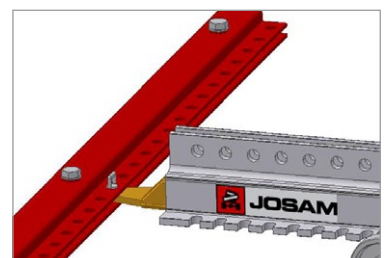
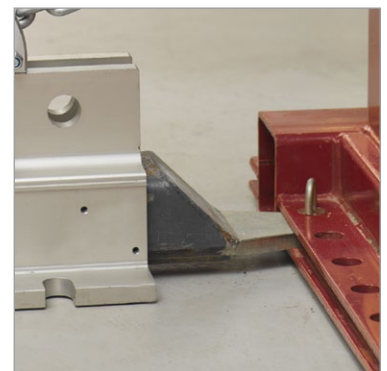
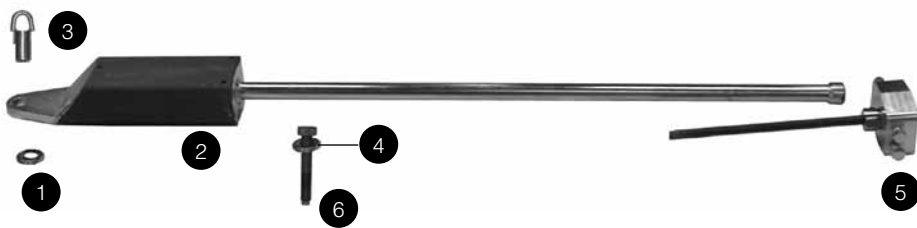



CT 41 AL/10781

Bracket kit for anchoring

Infästningssats för golvförankring

Haltersats för Bodenverankerung

#	Article #	Order #	Pcs.	EN	SE	DE
1	JO2423 AL	11567	1	Ear in aluminium	Öra i aluminium	Ohr aus Aluminium
2	JO2435 AL	11575	1	Complete chain bracket with pulley wheel AL	Komplett kättingfäste med brytrulle AL	Komplett Kettenhalter mit Umlenkrolle AL
3	JO2450-1	11594	3	Pin 35x100 aluminium	Sprint 35x100 aluminium	Steckbolzen 35x100 Aluminium
4	KL10-10-8M-13	14127	1	Chain 8 m with one hook	Kätting 8 m med krok	Kette 8 m mit einem Haken
5	KL13-10K	12304	1	Double hook 13-10 mm	Dubbelkrok 13-10 mm	Doppelhaken 13-10 mm

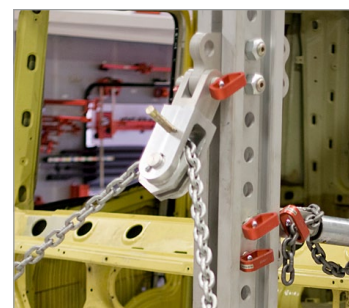
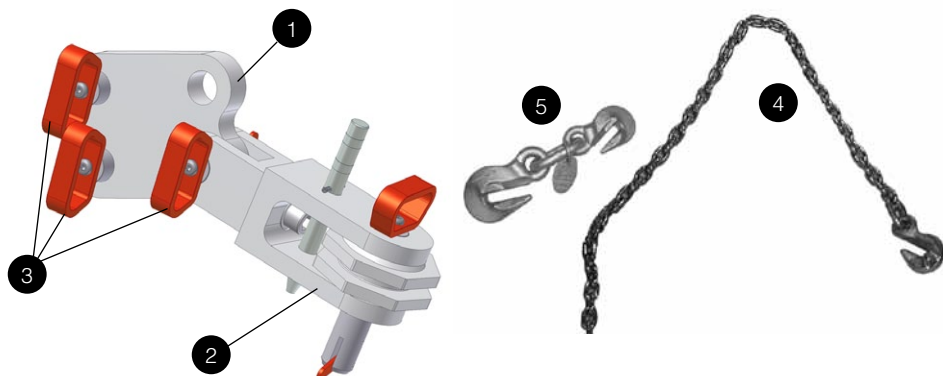



CT 51 AL/10782

Pulling kit with 127 mm stroke

Dragsats med 127 mm slaglängd

Ziehsatz mit 127 mm Hub

#	Article #	Order #	Pcs.	EN	SE	DE
1	I-CPF709	10973	1	Pull cylinder, 10 tons, 127 mm stroke	Dragcylinder, 10 ton, 127 mm slaglängd	Zugzylinder, 10 Tonnen, 127 mm Hub
2	JO 2370 K	11123	1	Knot complete with cylinder bracket	Knut komplett med cylinderfäste	Knoten kompl. mit Zylinderhalter
3	JO2423 AL	11567	1	Ear in aluminium	Öra i aluminium	Ohr aus Aluminium
4	JO2428-1	11570	1	Chain bracket 11 mm	Kättingfäste 11 mm	Kettenhalter 11 mm
5	JO2450-1	11594	3	Pin 35x100	Sprint 35x100	Splint 35x100
6	KL10-10-3M	12301	1	Chain 3 m with one hook	Kätting 3 m med krok	Kette 3 m mit einem Haken
7	JO2398	30102	1	Safety wire	Säkerhetsvajer	Sicherheitsdrahtseil

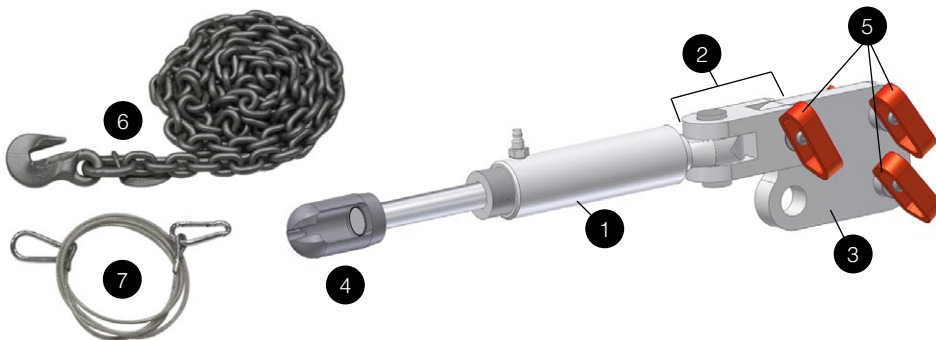



CT 52 AL/10783

Pulling kit with 500 mm stroke

Dragsats med 500 mm slaglängd

Ziehsatz mit 500 mm Hub

#	Article #	Order #	Pcs.	EN	SE	DE
1	I-CPA110-500	10972	1	Pull cylinder, 10 tons, 500 mm stroke	Dragcylinder, 10 ton, 500 mm slaglängd	Zugzylinder, 10 Tonnen, 500 mm Hub
2	JO2322 AL	11512	1	Knot in aluminium	Knut i aluminium	Knoten aus Aluminium
3	JO2423 AL	11567	1	Ear in aluminium	Öra i aluminium	Ohr aus Aluminium
4	JO2428-1	11570	1	Safety wire	Säkerhetsvajer	Sicherheitsdrahtseil
5	JO2450-1	11594	4	Pin 35x100 aluminium	Sprint 35x100 aluminium	Steckbolzen 35x100 Aluminium
6	KL10-10-3M	12301	1	Chain 3 m with one hook	Kätting 3 m med krok	Kette 3 m mit einem Haken
7	JO2398	30102	1	Safety wire	Säkerhetsvajer	Sicherheitsdrahtseil

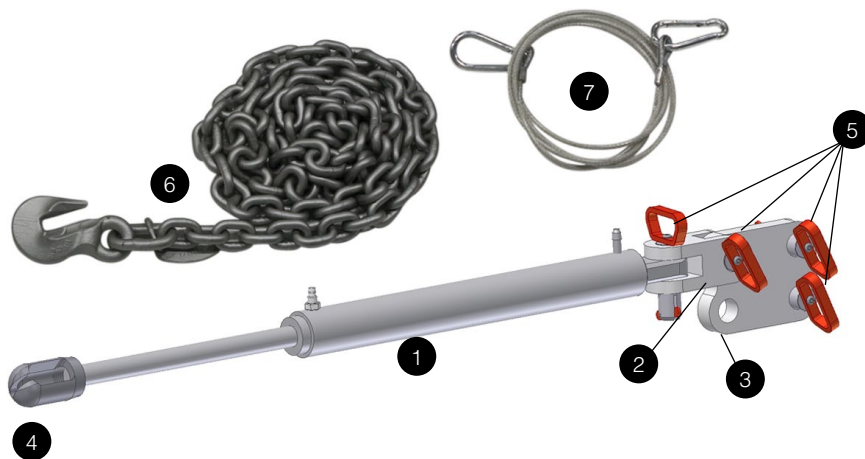



Drawing JO2324-B bus straightening
Ritning JO2324-B bussrikt
Plan JO2324-B Busrichten

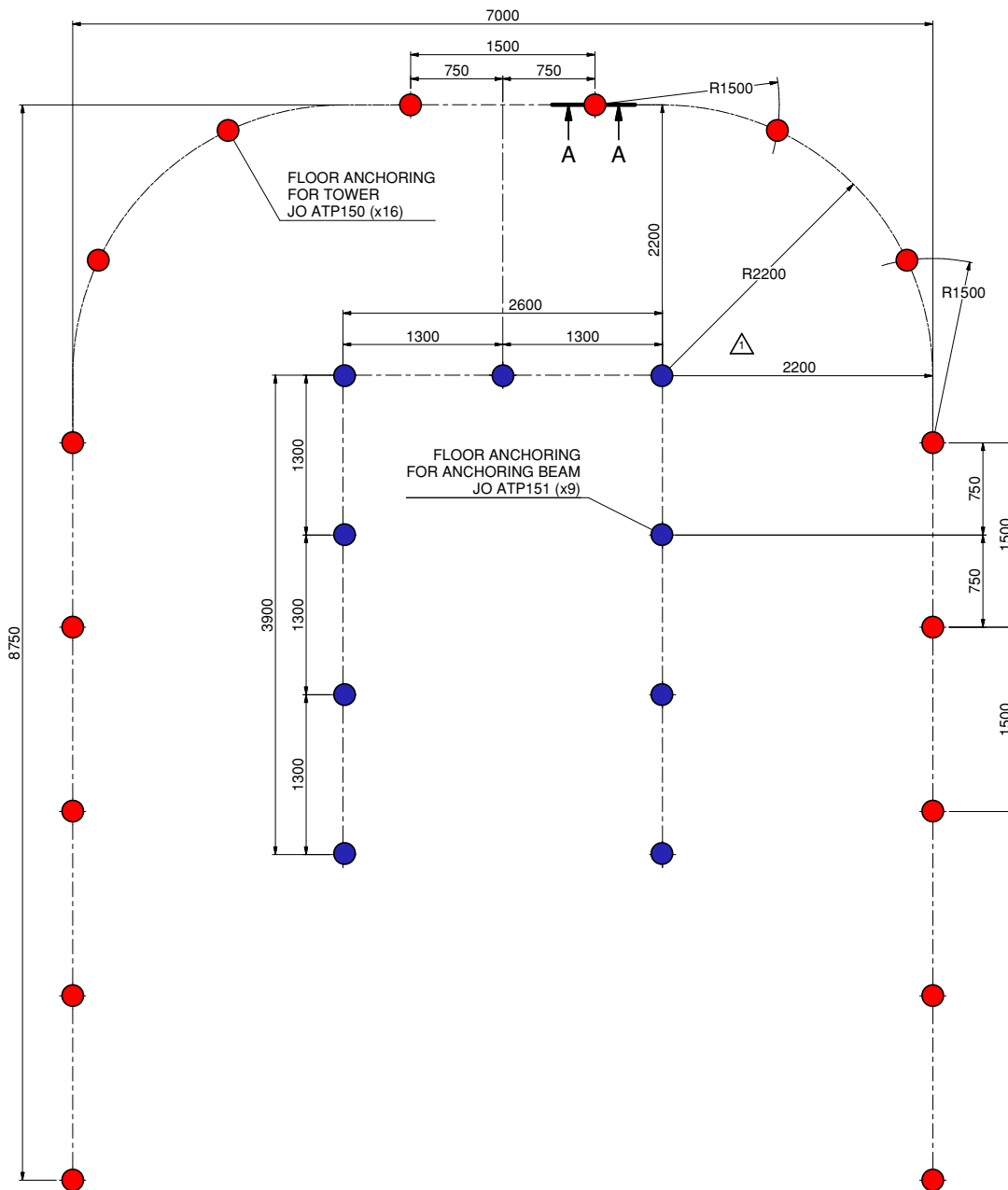
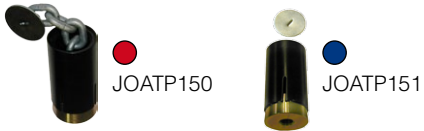



Drawing JO2324-C cab and bus straightening Ritning JO2324-C hytt- och bussrikt Plan JO2324-C Fahrerhaus- und Busrichten

